

Outgassing Compliant Coupled Inductors AE590PND

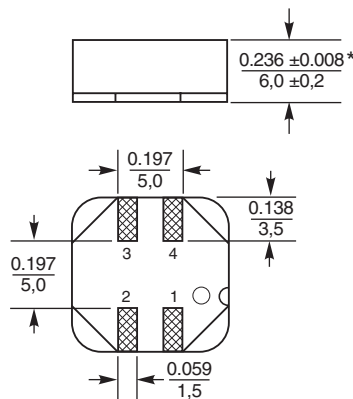

*Dimensions are for the mounted part.
Dimensions before mounting can be
an additional 0.006 inch (0,152 mm).

Dimensions are in $\frac{\text{inches}}{\text{mm}}$

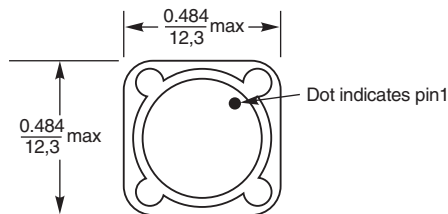
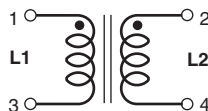
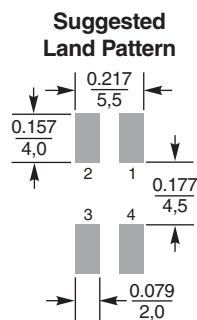

- Passes NASA low outgassing specifications
- High temperature materials allow operation in ambient temperatures up to 155°C.
- Excellent coupling coefficient ($k \geq 0.98$)
- Ideal for use in a variety of circuits including flyback, multi-output buck, SEPIC and Zeta.
- High inductance, high efficiency, excellent current handling and 500 V isolation in a very rugged part.
- Well suited for use as VRM inductors in high-current DC-DC and VRM/VRD controllers.
- Can also be used as two single inductors connected in series or parallel, as a common mode choke or as a 1 : 1 transformer.

Core material Ferrite

Core and winding loss [Go to online calculator](#)

Terminations Tin-lead (63/37) over tin over nickel over phos bronze

Weight: 2.8 – 3.2 g

Ambient temperature –55°C to +105°C with Irms current

Maximum part temperature +155°C (ambient + temp rise)

Storage temperature Component: –55°C to +155°C.

Tape and reel packaging: –55°C to +80°C

Winding to winding isolation 500 Vrms

Resistance to soldering heat Max three 40 second reflows at +260°C, parts cooled to room temperature between cycles

Moisture Sensitivity Level (MSL) 1 (unlimited floor life at <30°C / 85% relative humidity)

Winding-to-winding and winding-to-core isolation 500 Vrms

Enhanced crush-resistant packaging 500/13" reel;

Plastic tape: 24 mm wide, 0.35 mm thick, 16 mm pocket spacing, 6.6 mm pocket depth

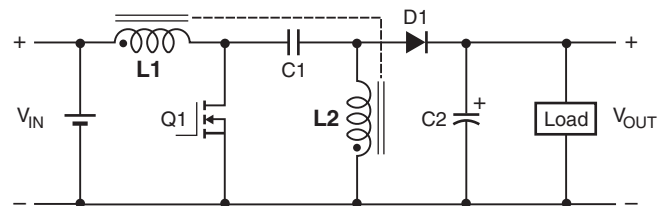

Typical SEPIC schematic

Refer to Application Note, Document 639,
"Selecting Coupled Inductors for SEPIC Applications"

AE590PND Series (1260)

Part number ¹	Inductance ² (μ H)	DCR max ³ (Ohms)	SRF (MHz) ⁴		Coupling coefficient typ	Leakage L typ (μ H)	Isat (A) ⁵			Irms (A)	
			min	typ			10% drop	20% drop	30% drop	both windings ⁶	one winding ⁷
AE590PND332MSZ	3.3 \pm 20%	0.020	41.0	52.0	0.98	0.20	11.50	12.90	14.10	3.60	6.10
AE590PND472MSZ	4.7 \pm 20%	0.036	30.0	38.0	0.98	0.20	9.00	10.18	11.08	3.16	4.47
AE590PND562MSZ	5.6 \pm 20%	0.040	24.0	30.0	0.98	0.20	8.00	9.06	9.84	3.00	4.24
AE590PND682MSZ	6.8 \pm 20%	0.048	22.0	27.0	0.98	0.24	7.00	8.00	8.64	2.75	3.88
AE590PND822MSZ	8.2 \pm 20%	0.052	21.0	26.0	0.98	0.25	6.44	7.38	7.98	2.63	3.72
AE590PND103MSZ	10 \pm 20%	0.060	18.0	22.0	0.99	0.26	5.40	6.32	6.88	2.45	3.46
AE590PND123MSZ	12 \pm 20%	0.074	16.0	20.0	0.99	0.28	5.30	6.18	6.70	2.21	3.12
AE590PND153MSZ	15 \pm 20%	0.085	14.4	18.0	0.99	0.32	4.60	5.30	5.80	2.06	2.92
AE590PND183MSZ	18 \pm 20%	0.097	13.0	16.0	0.99	0.40	4.50	5.22	5.68	1.93	2.73
AE590PND223MSZ	22 \pm 20%	0.116	12.0	15.0	0.98	0.67	4.00	4.62	5.02	1.76	2.49
AE590PND273MSZ	27 \pm 20%	0.124	10.0	13.0	0.99	0.50	3.60	4.14	4.50	1.70	2.41
AE590PND333MSZ	33 \pm 20%	0.134	10.0	12.4	0.99	0.65	3.30	3.80	4.14	1.64	2.32
AE590PND393MSZ	39 \pm 20%	0.142	9.6	12.0	0.99	1.09	3.00	3.48	3.82	1.59	2.25
AE590PND473MSZ	47 \pm 20%	0.174	9.3	11.6	0.99	0.80	2.70	3.12	3.40	1.44	2.03
AE590PND563MSZ	56 \pm 20%	0.198	8.4	10.5	0.99	0.75	2.50	2.90	3.14	1.35	1.91
AE590PND683MSZ	68 \pm 20%	0.216	8.0	10.0	>0.99	0.57	2.30	2.66	2.88	1.29	1.83
AE590PND823MSZ	82 \pm 20%	0.274	6.9	8.6	0.99	1.52	2.10	2.40	2.60	1.15	1.62
AE590PND104MSZ	100 \pm 20%	0.322	6.2	7.8	0.99	1.41	1.90	2.18	2.38	1.06	1.50
AE590PND124KSZ	120 \pm 10%	0.418	5.5	6.8	0.99	1.34	1.60	1.84	2.04	0.93	1.31
AE590PND154KSZ	150 \pm 10%	0.476	5.1	6.4	0.99	1.52	1.50	1.76	1.92	0.87	1.23
AE590PND184KSZ	180 \pm 10%	0.536	4.9	6.1	0.99	1.80	1.40	1.64	1.78	0.82	1.16
AE590PND224KSZ	220 \pm 10%	0.691	4.4	5.5	>0.99	1.60	1.30	1.48	1.60	0.72	1.02
AE590PND274KSZ	270 \pm 10%	0.806	3.4	4.3	>0.99	2.23	1.10	1.30	1.40	0.67	0.95
AE590PND334KSZ	330 \pm 10%	1.09	3.2	4.0	>0.99	2.39	1.00	1.16	1.26	0.57	0.81
AE590PND394KSZ	390 \pm 10%	1.20	2.9	3.6	>0.99	3.72	0.950	1.11	1.23	0.55	0.77
AE590PND474KSZ	470 \pm 10%	1.59	2.4	3.0	>0.99	2.89	0.900	0.994	1.09	0.48	0.67
AE590PND564KSZ	560 \pm 10%	1.81	2.2	2.8	>0.99	2.55	0.800	0.908	0.948	0.45	0.63
AE590PND684KSZ	680 \pm 10%	2.06	2.1	2.6	>0.99	5.76	0.700	0.804	0.874	0.42	0.59
AE590PND824KSZ	820 \pm 10%	2.65	2.0	2.5	>0.99	2.86	0.640	0.732	0.802	0.37	0.52
AE590PND105KSZ	1000 \pm 10%	3.06	1.9	2.4	>0.99	4.32	0.590	0.674	0.728	0.34	0.49

1. When ordering, please specify **testing** code:

AE590PND105KSZ

Testing: Z = Unscreened

H = Group A screening per Coilcraft CP-SA-10001

T = Screening per MIL-STD-981

U = Screening per EEE-INST-002

F = Screening per ESCC 3201

All screening performed to the document's latest revision

Custom screening also available

- Inductance shown for each winding, measured at 100 kHz, 0.1 Vrms, 0 Adc on an Agilent/HP 4284A LCR meter or equivalent. When leads are connected in parallel, inductance is the same value. When leads are connected in series, inductance is four times the value.
- DCR is for each winding. When leads are connected in parallel, DCR is half the value. When leads are connected in series, DCR is twice the value.
- SRF measured using an Agilent/HP 4191A or equivalent. When leads are connected in parallel, SRF is the same value.
- DC current, at which the inductance drops the specified amount from its value without current. It is the sum of the current flowing in both windings.
- Equal current when applied to each winding simultaneously that causes a 40°C temperature rise from 25°C ambient. See temperature rise calculation.
- Maximum current when applied to one winding that causes a 40°C temperature rise from 25°C ambient. See temperature rise calculation.
- Electrical specifications at 25°C.

Refer to Doc 639 "Selecting Coupled Inductors for SEPIC Applications."
Refer to Doc 362 "Soldering Surface Mount Components" before soldering.

Coupled Inductor Core and Winding Loss Calculator

This web-based utility allows you to enter frequency, peak-to-peak (ripple) current, and Irms current to predict temperature rise and overall losses, including core loss. [Go to online calculator.](#)



CRITICAL PRODUCTS & SERVICES

© Coilcraft, Inc. 2017

1102 Silver Lake Road
Cary, IL 60013
Phone 800-981-0363

Fax 847-639-1508
Email cps@coilcraft.com
www.coilcraft-cps.com

Document AE703-1 Revised 05/30/17

This product may not be used in medical or high risk applications without prior Coilcraft approval. Specifications subject to change without notice. Please check our web site for latest information.

AE590PND Series (1260)

Typical L vs Current

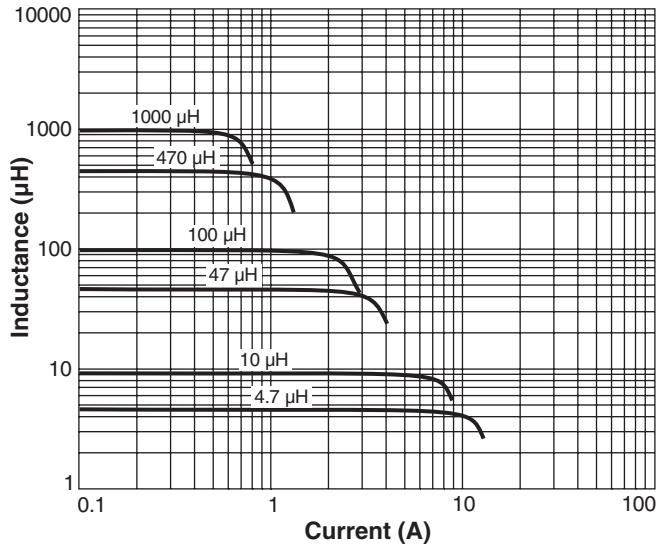

Typical L vs Frequency

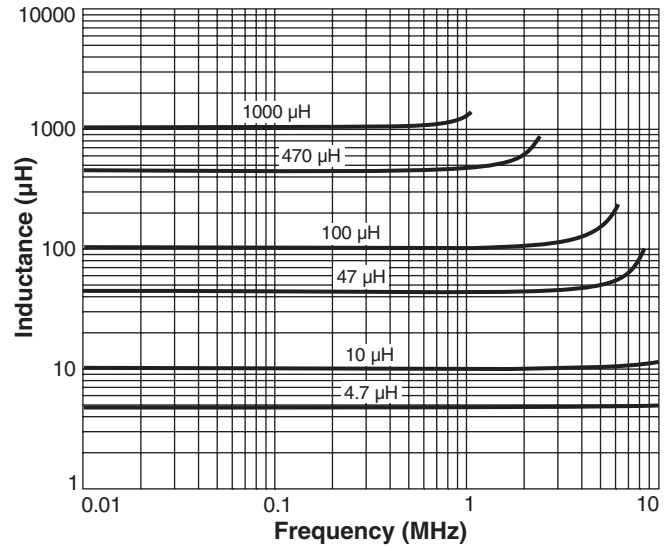

CRITICAL PRODUCTS & SERVICES

© Coilcraft, Inc. 2017

1102 Silver Lake Road
Cary, IL 60013
Phone 800-981-0363

Fax 847-639-1508
Email cps@coilcraft.com
www.coilcraft-cps.com

Document AE703-1 Revised 05/30/17

This product may not be used in medical or high risk applications without prior Coilcraft approval. Specifications subject to change without notice. Please check our web site for latest information.